

➤ THERE'S
NOTHING
LIKE IT!



STACER

DAWN DUTY
The first rays of sun illuminate mist rising from the glassy water, disturbed only by the sounds of the waking birds morning calls and water lapping against your Stacer... now that's dawn duty.



FAMILY MOMENTS

Whether it's their first fish or the one that got away, there are endless family moments just waiting to be lived in a Stacer. Live, laugh and play.



CHOOSE YOUR



ADRENALIN SEEKING

If it's boats that get your blood pumping and your heart thumping, then why wait? Whether its offshore fishing, wakeboarding or water skiing, start your next thrill-seeking adventure with a Stacer!

TIME OUT

Don't get stuck on auto pilot, take a time out from the 'everyday' and make your weekends special. Recharge your batteries with no computers, emails, video games... just quality time with you, friends and family.





ROMANTIC ESCAPES

Always dream of escaping to your own private beach for a romantic break? Make dreams next weekends holiday plans with your Stacer and explore your local waterways for that ideal secluded spot.

PIONEERING

Look to the open ocean and long for adventure? Longing to explore and discover new untouched waterways? Embrace your inner explorer, Stacer will get you there.



R ADVENTURE

STACER.COM.AU <<

no matter what
your dreams may be,
Stacer has you covered!



WHY CHOOSE STACER

- + Wide Dealer Network
- + A Solid History
- + Strength & Durability
- + Value for Money
- + Extensive Range
- + Superb Design

A LIFETIME OF BOATING

At Stacer we are dedicated to providing quality products that deliver superior value and performance. We have over 40 years experience in boating and are a renowned leader in the aluminium boat industry.



NOT JUST A BOAT!

When you buy a Stacer, you get so much more than just a boat! As a Stacer customer, you're backed by our 3 year factory warranty for peace of mind. Stacer also has a network of over 60 qualified marine retailers nationwide, so you can feel confident knowing there is always a dealership nearby to assist with any service or warranty enquiries.

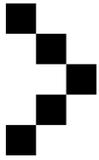

As a Stacer owner you can enjoy all the benefits of a stylish, dependable Australian made and owned product that represents all that is youthful and fun.



STACER TRAILERS

Cradle your pride and joy with a purpose built steel galvanised or aluminium Stacer trailer.

Each model has been perfectly matched with a Stacer trailer to make towing, launching and retrieving a breeze. Our trailers have been rigorously tested to withstand even the toughest journey, for more information refer to page 50.

KEEPING BOATING FUN!

At Stacer, we want to eliminate the hassle and make buying your boat FUN! Stacer's Ready2Go packages keep it simple, so you can get out on the water faster! Simply choose your favourite boat and then it is paired with the relevant Stacer Trailer and Evinrude outboard. Your package is then assembled, fitted and pre-rigged at the Stacer factory and covered by our 3 Year factory warranty, ready for your first outing!



EASY-FOLD REAR LOUNGE

Taking time out is even easier with our new 'Easy Fold' rear lounge. In one fluid motion the lounge folds down from being flush with the transom... so a comfy seat is never far away, and never underfoot!

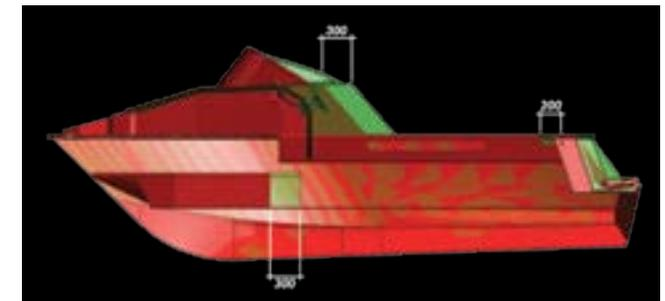

■ OLD ■ ADDITIONAL SPACE

LOW PROFILE SPORTS DECK

Our new Low Profile Sports Deck combines a raised top deck with a low profile windscreen for an improved driving position and a modern, sportier look. The new LPSD is featured on Baymaster (excl 449), Easy Rider and Sportster models.



BIG BUNKS

Our new range of Stacer cabins are perfect for families and fishos alike; now with larger 6 foot bunks, even more cockpit space and a larger more protected cabin design.

INNOVATIVE DESIGNS

Using the latest technology and innovative design Stacer produces a range of hull designs that deliver outstanding performance on the water.

EVO HULLS

We're proud of our new hull design, but we're also proud of our original EVO Hull which has a solid reputation for quality and reliability. Using a reverse chine design The EVO Hull continues to be used on many of our smaller models deliver superb stability and performance.

EVO ADVANCE

Stacer's new EVO Advance Hull brings a new height to boating adventure offering the perfect combination of storage, stability and rough water performance. Built on the foundations of the renowned EVO Hull, the EVO Advance Hull is our most advanced hull design.

PROLINE SPORTS HULL

The Proline Sports Hull is featured on the Proline range and sees the already wide beam of the Proline range come forward to the bow to provide superb stability for casting and the v-shape delivers a smooth ride.

SF SPORTS HULL

Exclusive to the Barra Pro models, the SF Sports Hull combines the sleek spray deflecting plate side sheets of the EVO Advance Hull with a concave high performing bottom sheet design. The result is a high performing hull that glides over the water and provides superb stability at rest. The hull also offers a unique tournament style transom with more usable space and storage.



EVO ADVANCE

Sharper Entry, Smoother Ride

The EVO Advance Hull takes Stacer's design principals to a whole new level. Featuring the combination of a sharper bow design (1) and a deeper V (2) the EVO Advance Hull delivers a smoother ride and impressive overall performance.

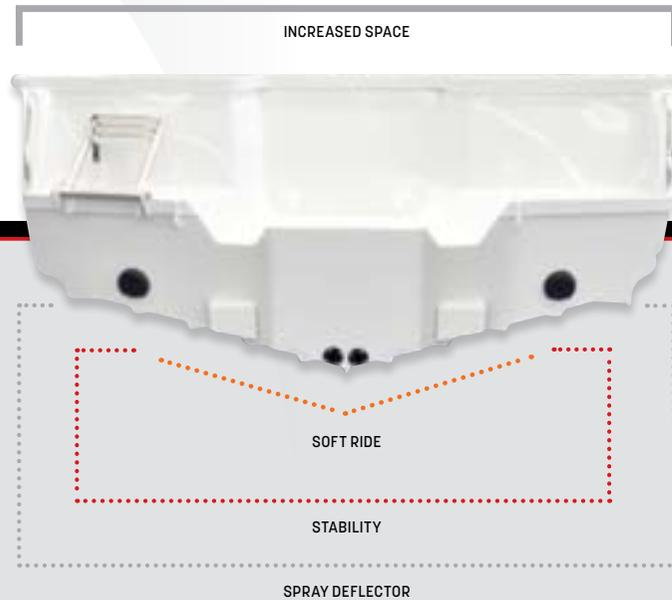
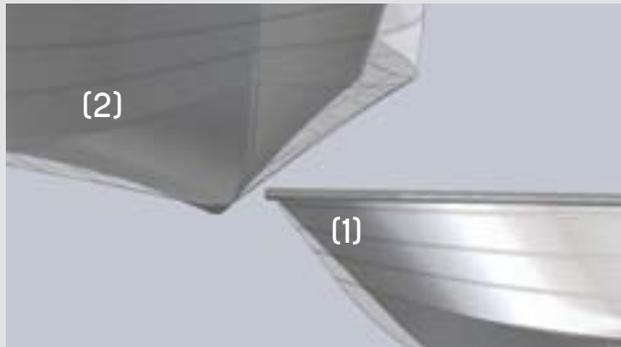

Increased Space

The new transom of the EVO Advance Hull was designed to increase cockpit space and also make boarding easy by enclosing engine cables inside the transom keeping the boarding platform obstruction free.

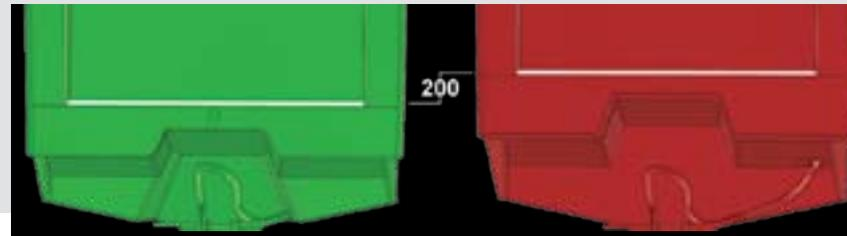

■ The EVO Advance Hull delivers on average 200mm more internal space.

Gunnel Bump Rubber

Stacer boats are built tough with a Gunnel Bump Rubber to keep your paint in top condition. This rubber insert runs along the gunnels protecting your boat when pulling up at a jetty or coming alongside other vessels.



Level Flotation

Level Flotation is standard across the majority of the Stacer range, making our boats some of the safest on the water. Level Flotation enables Stacer boats to remain level and upright when swamped in calm water with passengers and cargo on board. For advice on whether your Stacer features Level or Basic flotation, contact your local dealer.

POWER FOR ANY NEED

PERFECT ENGINE CHOICE

Powering with an Evinrude E-TEC engine will give you even more time on the water.

You will benefit from Evinrude outboard engines low maintenance requirements - no dealer scheduled maintenance for 3 years or 300 hours - and superior fuel efficiency. And with class leading power and torque combined with greater control and handling, Evinrude offers enhanced outboard performance.

Old Tech or E-TEC. The choice is yours.



Easy to own & operate

- No scheduled dealer servicing for the first 3 years or 300 hours.
- No break-in period of oil changes.



Clean & quiet

- Cleanest engine on the water.
- Quietest engine on the water.



Durability, quality & reliability

- Fewer parts. Fewer problems.
- S.A.F.E. system; which automatically switches your engine to protect mode in the unlikely event of loss of oil or overheating.



Power & performance

- Best in class acceleration.
- Best in class fuel-efficiency.



EVINRUDE





POWER FOR ANY BUDGET



MORE AFFORDABLE

When you buy a Stacer-Vortex Ready2Go Boat, Motor, Trailer Package you're buying a product backed and owned by Australia's largest Aluminium boat manufacturer.

With a Stacer-Vortex Package getting into boating has never been easier on the wallet. We're proud to say that Vortex engines are on average approximately 25% more affordable than a comparable outboard, so you can get into the boating package you've always wanted. Look no further than a Vortex outboard, backed by a 3 year warranty for peace of mind.

The Vortex range currently encompasses over 20 models with more still to come, starting with 2.5hp and ranging up to 40hp. Power your Stacer boating package with either a gutsy Vortex 2 stroke or fuel efficient 4 stroke engine in a tiller-steer or forward control configuration. The Vortex range also includes engines in a choice of manual or electric start.

For more information, specifications and images of the Vortex range visit www.vortexmarine.com.au

Vortex Warranty

Buying a boat is a big decision and can also be a big investment. With a Vortex outboard engine you receive value for money as well as peace of mind.

All Vortex engines are covered by a 3 year warranty backed by Telwater Australia's largest aluminium boat manufacturer. Telwater has over 20 years' experience in manufacturing and distributing Marine products. Now that's peace of mind!

**3 YEAR
WARRANTY**

MORE FOR YOU

WWW.STACER.COM.AU

Stacer Build my boat

Design your dream boat with the new Stacer 'Build My Boat' function. Customise your chosen model with our range of options, colours, stripes and wraps and then submit your request for a quote with your local dealer. Be the envy of every fisherman on the water with your one of a kind custom Stacer.

Find and compare your Stacer

Feeling a bit unsure about which model will suit your needs? Use our 'Find Your Stacer' tool to narrow down your search. Fill in the number of people you would like the boat to accommodate and also the size of your ideal boat. Once you have narrowed down the search, you can compare the specs of the boats on your list.

Stacer out and about

Out and about and need some Stacer information? Not to worry, the new Stacer mobile site has everything at your fingertips. Scan this QR code to visit our website and look out for these throughout our catalogue.

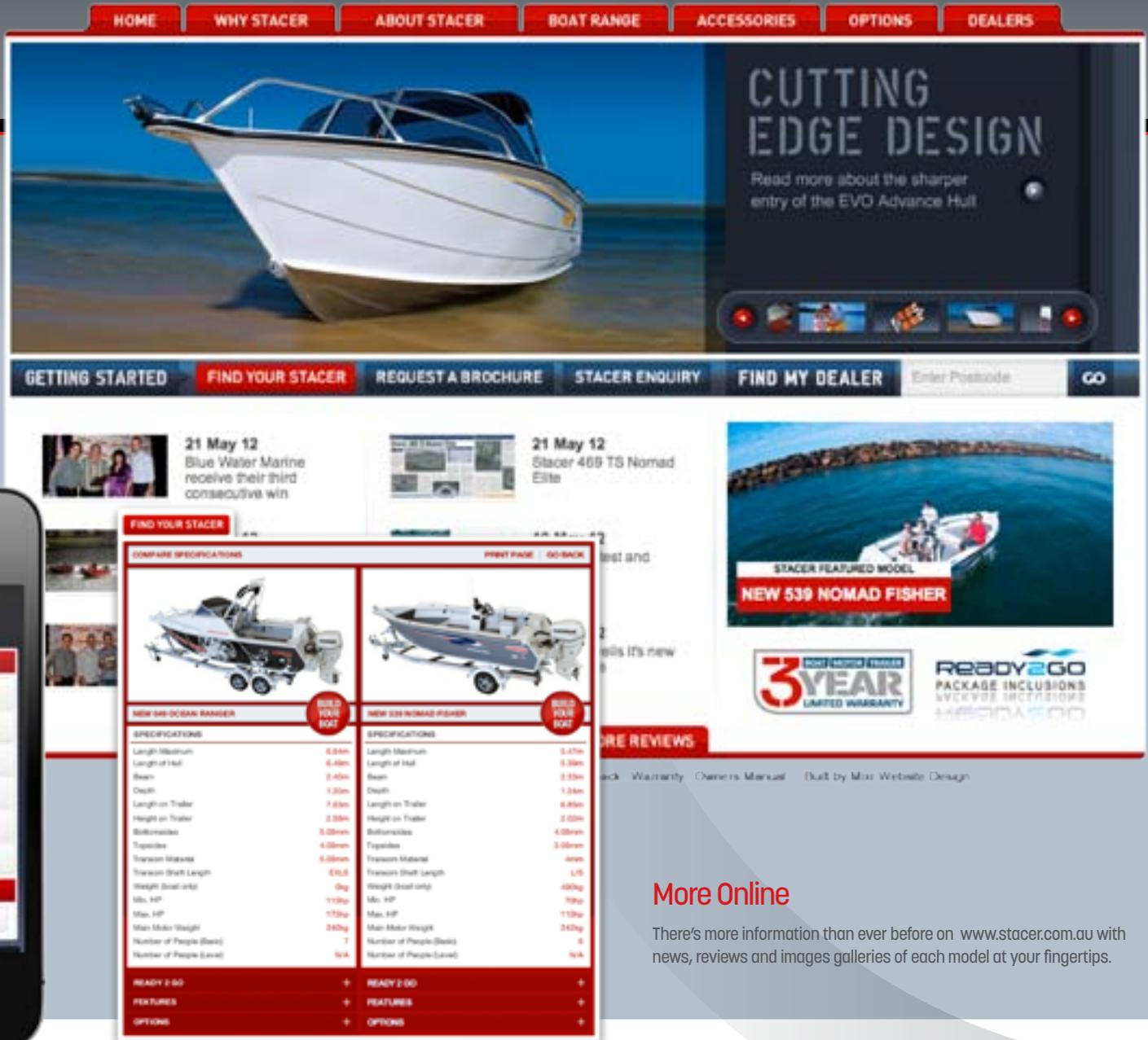
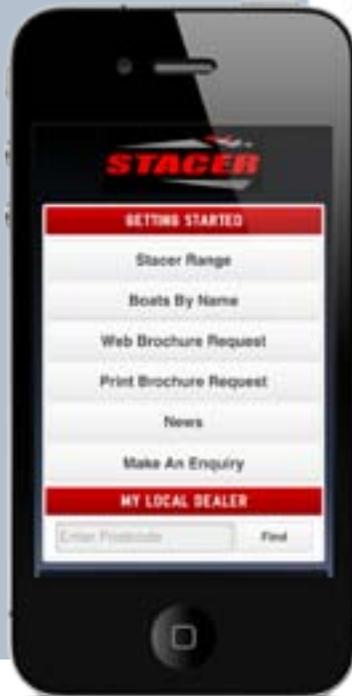

More Online

There's more information than ever before on www.stacer.com.au with news, reviews and images galleries of each model at your fingertips.

CHOOSE YOUR ELECTRONICS

LOWRANCE® HDS

HDS: Upgrade.

Tried and true, Lowrance HDS multifunction displays are amongst Australia's most popular. Chartplotter, Sounder, Radar, Engine monitoring and much more... HDS delivers all you need for a safe and enjoyable experience on the water.

- Built-in Broadband Sounder and GPS antenna
- A huge range of performance module options, including StructureScan™ with DownScan™ imaging for life-like imaging of the world below your Stacer.



SIMRAD NSS SPORT

NSS Sport: Upgrade.

With its Touch Sensible™ technology, the all-new Simrad NSS Sport is extremely simple to operate. The bright and stylish 6.4, 8 or 12.1 inch displays make them the perfect partner for every Stacer owner. And with full networking capabilities, they offer effortless performance and integration.

- Built-in Broadband Sounder and GPS antenna
- Powerfully fast charting
- Bright LED back sunlight viewable display
- Expandable: add best in class performance modules to meet your needs. Radar, performance Sounder, Entertainment, Autopilot, StructureScan and more.

LOWRANCE®

Mark and Elite: Standard Fit.

- Elite: 5-inch colour displays. Available as Fishfinder only, Chartplotter only, Fishfinder/Chartplotter combo with new additions of DSI DownScan™ Imaging and DownScan Imaging / Chartplotter combos
- Mark: 5-inch grayscale fishfinders. Three models are available, including the new Mark 5x DSI DownScan™ Imaging fishfinder.



+ SIMRAD NSS TOUCHSCREEN: UPGRADE

+ SONICHUB

+ LOWRANCE MARK AND ELITE: STANDARD FIT

FEATURES	SIMRAD NSS	LOWRANCE HDS	LOWRANCE MARK & ELITE
NETWORKABLE - NMEA 2000, SIMNET AND ETHERNET PLUG AND PLAY ANY LOWRANCE OR SIMRAD MODULE.	+	+	
STRUCTURESCAN - THE ULTIMATE IN REALITY ECHO SOUNDING.	+	+	DSI MODELS ONLY
BROADBAND 3G RADAR - A REVOLUTION IN RADAR.	+	+	
BUILT-IN BROADBAND SOUNDER - INCREDIBLE ECHO CLARITY.		NSS7 AND NSS8	+
SONICHUB - ROCK YOUR BOAT - INTEGRATE YOUR DISPLAY WITH AN IPOD, IPHONE OR COMPATIBLE DIGITAL MUSIC DEVICE.	FREE	+	
TOUCH SCREEN - BRAND NEW TOUCH SENSIBLE TECHNOLOGY. THE REINVENTION OF THE MARINE TOUCH SCREEN		+	



BOWRIDERS

STACER.COM.AU «

The Bowrider Range offers boating families more than just a comfortable ride; they are the true all-rounder, capable of being used for fishing, skiing, tube riding or simply cruising the waterways for the perfect haven.

The Stacer bowrider range features the superb riding and stability of the EVO Advance Hull with a sharper bow entry and a deeper V for an impressive ride.

The bowrider range also features the new Low Profile Sports Deck. By incorporating the new deck and reducing the size of the windscreen we have created a more modern sporty look for the range.





THE RANGE

489 Easy Rider // 509 Easy Rider
 539 Easy Rider // 569 Easy Rider
 589 Easy Rider // 549 Sportster
 579 Sportster // 609 Sportster

BR

BOWRIDERS

FEATURING

539 EASY RIDER
 EVO Advance Hull
 Low Profile Sports Deck
 Folding Rear Lounge
 Bow Cushions with Storage
 Upholstered Side Panels
 Pole Mount Insert



EVO
ADVANCE

549 SPORTSTER
 EVO Advance Hull
 Low Profile Sports Deck
 Bow Cushions with Storage
 Mercruiser Sterndrive Engine
 Sun Lounge
 Central Ski Hook
 Duckboard



EVO
ADVANCE

BR

BOWRIDERS



539 EASY RIDER

FEATURED BOAT // A



539 Easy Rider

Whether it's fishing, water sports or lounging around, the 539 Easy Rider has got it covered. This model features the new EVO Advance hull for more internal space and improved performance.

Optional wrap shown.



489 Easy Rider

This entry level model comes with all the layout benefits and features of a larger boat in a more compact size. The 489 Easy Rider features the new Low Profile Sports Deck new to Stacer and deluxe rear lounge.

Old model shown.



B // 489 EASY RIDER



509 Easy Rider

Families looking for versatility and value for money need look no further than the 509 Easy Rider. Laze in the sun on the rear lounge or quickly transform the bow lounge into a fishing platform.

Old model shown.



C // 509 EASY RIDER



569 Easy Rider

This sporty model stands out on the water, with a long list of features including bimini and envelope, glove box, carpeted floor and rear folding lounge just to name a few.



D // 569 EASY RIDER



539 Easy Rider
EVO ADVANCE HULL
UNDERFLOOR STORAGE
BIMINI & ENVELOPE



MEASUREMENTS	489 ER	509 ER	539 ER	569 ER
LENGTH MAXIMUM:	4.95M	5.25M	5.55M	5.85M
LENGTH OF HULL:	4.81M	5.09M	5.39M	5.69M
BEAM:	2.20M	2.20M	2.33M	2.33M
DEPTH:	1.08M	1.14M	1.24M	1.30M
LENGTH ON TRAILER:	6.60M	6.85M	6.85M	6.85M
HEIGHT ON TRAILER:	1.92M	1.90M	2.11M	2.11M
BOTTOMSIDES:	3.00MM	3.00MM	4.00MM	4.00MM
TOPSIDES:	2.50MM	2.50MM	2.50MM	2.50MM
TRANSOM MATERIAL:	3.00MM	3.00MM	4.00MM	4.00MM
TRANSOM SHAFT LENGTH:	L/S	L/S	L/S	L/S
WEIGHT (BOAT ONLY):	450KG	510KG	580KG	590KG
MIN. HP:	50HP	60HP	70HP	90HP
MAX. HP:	75HP	115HP	130HP	150HP
MAIN MOTOR WEIGHT:	184KG	203KG	242KG	242KG
NUMBER OF PEOPLE (BASIC):	5	6	7	7
NUMBER OF PEOPLE (LEVEL):	N/A	5	6	6
PACKAGE TRAILER:	TQAVL48B	TQAVL51B	TQAVL58BW	TQAVL58BW
STANDARD				
ACCESSORY KIT	+	+	+	+
BOW STORAGE	+	+	+	+
COCKPIT LIGHTS	+	+	+	+
COVERS: BIMINI & ENVELOPE	+	+	+	+
FOLD DOWN DRINK HOLDER	+	+	+	+
FUSION MSRA200 STEREO & 200W SPEAKERS	+	+	+	+
LOW PROFILE SPORTS DECK	+	+	+	+
MAXI BRACKET	+	+	+	+
PAINTED WITH STRIPES	+	+	+	+
POLE MOUNT INSERT	+	+	+	+
RAILS: AFT SHORT SIDE	+	+	+	+
RAILS: SHORT LOW BOWRAILS	+	+	+	+
REAR LADDER	+	+	+	+
ROD HOLDERS (2)	+	+	+	+
SEAT: BOW CUSHIONS	+	+	+	+
SEAT: FOLDING REAR LOUNGE	+	+	+	+
SEAT: MARITIME	+	+	+	+
STEERING: NON RETURN MECHANICAL	+	+	+	+
TRANSDUCER BRACKETS X 2	+	+	+	+
UNDERFLOOR FUEL TANK	77L	77L	95L	118L
VHF RADIO & ANTENNA	+	+	+	+
OPTIONS				
BURLEY BUCKET	+	+	+	+
COVERS: BIMINI & ENVELOPE N.T	+	+	+	+
COVERS: FRONT CLEARS	+	+	+	+
COVERS: SIDE CLEARS	+	+	+	+
COVERS: TONNEAU COVER	+	+	+	+
COVERS: TRAVEL COVER	+	+	+	+
CUTTING BOARD (ALLOY)	+	+	+	+
LIVE BAIT TANK BACK DECK	+	+	+	+
PAINT: TWO TONE	+	+	+	+
REMOVABLE COCKPIT TABLE	+	+	+	+
ROD HOLDERS (2)	+	+	+	+
SEAT: BUNK INFILL WITH CUSHION	+	+	+	+
SKI HOOKS (PAIR)	+	+	+	+
SKI POLE	+	+	+	+
SOUNDER: MARK 5X FISHFINDER	+	+	+	+
STEERING: UPGRADE TO HYDRAULIC	+	+	+	+
TRANSOM DOOR	+	+	+	+
TWIN BATTERY BOX & SWITCH	+	+	+	+
VINYL WRAP	+	+	+	+

549 SPORTSTER

FEATURED BOAT // A



549 Sportster

The 549 Sportster offers cruising comfort for up to seven people with ample storage space. This model features a new lounge designed to maximise cockpit space without compromising on comfort, making it luxurious, powerful and hard to keep away from!

Optional wrap shown.



589 Easy Rider

With all the same features in a bigger and more powerful package, the 589 Easy Rider is ready for anything from skiing to fishing; standard with bimini and envelope, folding rear lounge, telescopic ladder and ski locker to name a few.

Old model shown.



B // 589 EASY RIDER



C // 579 SPORTSTER



D // 609 SPORTSTER

579 Sportster

Catering comfortably for up to seven passengers and featuring a spacious rear boarding platform, the 579 Sportster is luxury on water. To turn luxury into adventure, option up with a casting platform infill and extra rod holders and take the crew fishing.

609 Sportster

Introducing the largest of the Bowrider range, the 609 Sportster. This powerful beauty has all you could need for on water adventure and features thick plate sides, a deluxe sun lounge and carpeted floors.

Old model shown with optional sun lounge and two tone paint.

549 Sportster

FUSION STEREO & SPEAKERS

LOW PROFILE SPORTS DECK

QUARTER SEATS

609 Sportster

SUN LOUNGE

POWER STEERING

BOW CUSHIONS & STORAGE

EVO
ADVANCE

MEASUREMENTS

	549SP	589ER	579SP	609SP
LENGTH MAXIMUM:	6.09M	6.05M	6.39M	6.69M
LENGTH OF HULL:	5.49M	5.89M	5.79M	6.09M
BEAM:	2.33M	2.48M	2.33M	2.48M
DEPTH:	1.24M	1.37M	1.30M	1.37M
LENGTH ON TRAILER:	6.85M	7.18M	7.18M	7.18M
HEIGHT ON TRAILER:	2.11M	2.20M	2.11M	2.20M
BOTTOMSIDES:	4.00MM	4.00MM	4.00MM	4.00MM
TOPSIDES:	2.50MM	4.00MM	2.50MM	4.00MM
TRANSOM MATERIAL:	4.00MM	4.00MM	4.00MM	4.00MM
TRANSOM SHAFT LENGTH:	ALPHA	EXLS	ALPHA	ALPHA
WEIGHT (BOAT ONLY):	630KG	710KG	687KG	815KG
MIN. HP:	135HP	115HP	135HP	190HP
MAX. HP:	135HP	150HP	135HP	220HP
MAIN MOTOR WEIGHT:	315KG	256KG	315KG	393KG
NUMBER OF PEOPLE (BASIC):	7	7	7	8
NUMBER OF PEOPLE (LEVEL):	N/A	6	N/A	N/A
PACKAGE TRAILER:	TQAVL58BW	TQAVL61BWT	TQAVL58BW	TQAVL61BWT

STANDARD

ACCESSORY KIT	+	+	+	+
BOW SPRIT & BOWROLLER	+	+	+	+
BOW STORAGE	+	+	+	+
CENTRAL SKI HOOK	+	+	+	+
COVERS: BIMINI & ENVELOPE	+	+	+	+
DUCKBOARD PLATFORM	+	+	+	+
FOLD DOWN DRINK HOLDER	+	+	+	+
FUSION MSRA200 STEREO & 200W SPEAKERS	+	+	+	+
LOW PROFILE SPORTS DECK	+	+	+	+
MAXI BRACKET		+		
MERCURUISER 3.0L TKS 135HP	+		+	
MERCURUISER 4.3L TKS 190HP				+
POLE MOUNT INSERT		+		
RAILS: AFT SHORT SIDE		+		
RAILS: SHORT LOW BOWRAILS	+	+	+	+
REAR LADDER		+		
ROD HOLDERS (2)	+	+	+	+
SEAT: BOW CUSHIONS	+	+	+	+
SEAT: FOLDING REAR LOUNGE		+		
SEAT: MARITIME	+	+	+	+
SEAT: QUARTER SEATS	+	+	+	+
STEERING: HYDRAULIC		+		
STEERING: POWER STEERING	+		+	+
TELESCOPIC REAR LADDER	+		+	+
TRANSDUCER BRACKETS X 2	+	+	+	+
UNDERFLOOR FUEL TANK	95L	160L	118L	160L
VHF RADIO & ANTENNA		+		

OPTIONS

BURLEY BUCKET		+		
COVERS: BIMINI & ENVELOPE N.T	+	+	+	+
COVERS: FRONT CLEARS	+	+	+	+
COVERS: SIDE CLEARS	+	+	+	+
COVERS: STORM COVER	+	+	+	+
COVERS: TONNEAU COVER	+	+	+	+
CUTTING BOARD (ALLOY)		+		
PAINT: TWO TONE	+	+	+	+
REMOVABLE COCKPIT TABLE	+	+	+	+
SEAT: BUNK INFILL WITH CUSHION	+	+	+	+
SEAT: SUN LOUNGE	+	+	+	+
SKI HOOKS (PAIR)		+		
SKI POLE		+		
SOUNDER: MARK 5X FISHFINDER	+	+	+	+
TRANSOM DOOR		+		
TWIN BATTERY BOX & SWITCH		+		
VHF RADIO & ANTENNA	+		+	+
VINYL WRAP	+	+	+	+

CHOOSE YOUR OPTION

Accessory Kit Includes:
 + Battery Box + Isolator Switch + Auto Bilge Pump
 + Switch Panel + Navigation Lights
 For more accessory options visit www.stacer.com.au

SIDE POCKET



BAIT BOARD



3/4 REAR FOLDING LOUNGE & TRANSOM BACK REST



SKIPPER SEAT



MARITIME SEAT



ROD RACK LOCKER

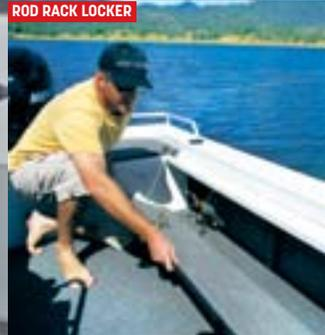

SPORTS CONSOLE



TELESCOPIC LADDER



SKI POLE



SIDE CONSOLE



TRANSOM STEP



TRANSOM DOOR SHUT



FUEL TANK RACK



GME CD/RADIO



TRANSOM MOUNTED LIVE BAIT TANK



FISH BOX SEAT



BAIT BOARD & LIVE BAIT TANK



LOWRANCE SOUNDER



TRANSOM DOOR OPEN



BURLEY BUCKET



LOWRANCE VHF RADIO



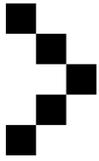

CHOOSE YOUR COLOUR

STRIPES & COLOURS

Once you have decided on your choice of boat - now is the chance to colour coordinate stripe decals and canopy colours to suit your individual taste. View the colour examples below to ensure your Stacer boat stands out from the crowd!

BOAT STRIPES

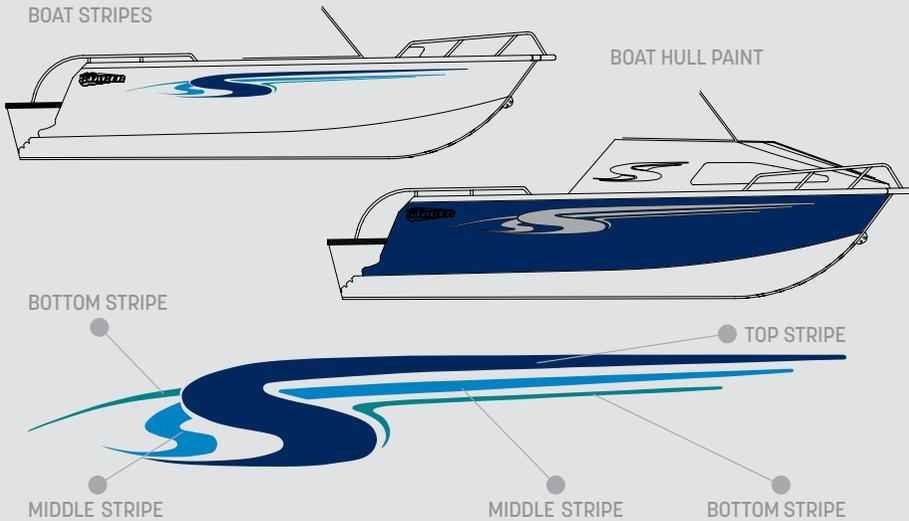

Stripe Colours >

- DARK GREEN
- TEAL
- OLYMPIC BLUE
- SAPPHIRE BLUE
- OCEAN BLUE
- BLACK
- LIGHT GREY
- BURGUNDY
- RED
- YELLOW
- TAUPE
- WHITE

Two Tone Boat Colours >

- LIGHT BLUE
- SUNBURN
- BLACK
- CLOUD GREY
- RED
- DUNE
- NAVY
- TOXIC GREEN

CHOOSE YOUR WRAP



GALAXY



TRIBAL

WRAPS Don't just stand out from the crowd - jump out!

Our UV stabilised laminate offers extra durability in four eye-catching designs, in a selection of colours.

- + choose from our four designs or supply your own
- + included under 3 year warranty
- + more resistant to chips and scratches than paint
- + high quality adhesive vinyl covered with a UV stabilised laminate for extra durability
- + applied at the factory by our specialised team

WRAP DESIGNS & COLOURS AVAILABLE:

- GALAXY** Available in Blue, Green, Orange and Red
- SPLINTER** Available in Blue, Green, Orange, Purple and Red
- TRIBAL** Available in Blue, Light Blue Green, Grey, Toxic Green and Red
- HOKED** Available in Blue, Light Blue, Green, Toxic Green and Red



SPLINTER



HOKED

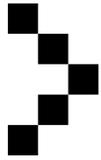

CHOOSE YOUR COVER



CANOPY



BIMINI & ROCKET LAUNCHER



BIMINI FRONT & CLEAR SIDES



NT & NQ BIMINI



BIMINI EXTENSION - LARGE



BIMINI EXTENSION



NOMAD BIMINI



BOWRIDER TONNEAU COVER



CABIN FRONT HATCH COVER

JET BLACK

WHITE ON GREY

RED

CAPTAIN NAVY

CADET GREY

BURGUNDY

PERSIAN GREEN

PACIFIC BLUE

TOAST

Canopies and Biminis
Option up to have front and side clears or side curtains for further protection. Storm and tonneau covers are also available - all in a range of colours to match your boat!

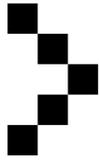

V-LOADER SERIES (TQ48VBH)

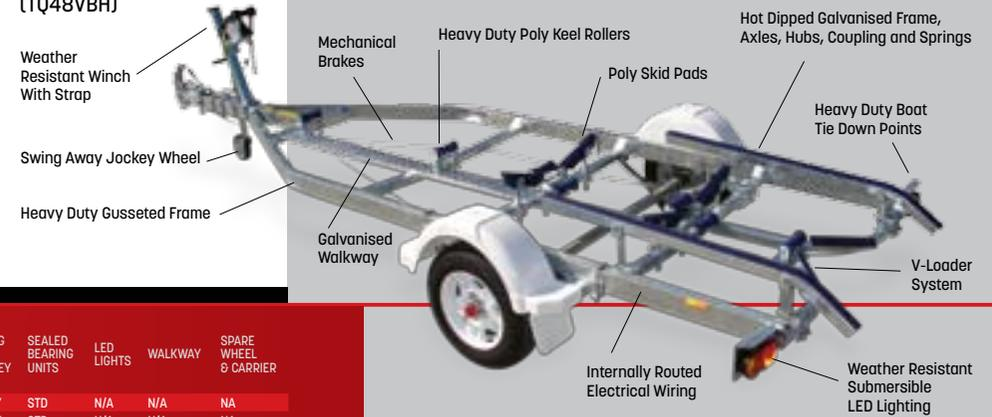

TRAILER CODE	DESCRIPTION	ATM KG	HEIGHT CM	LENGTH CM	TARE WEIGHT KG	WIDTH CM	BRAKES	TYRE SIZE	ALLOY/STEEL WHEELS	GALVANISED AXLE/SPRING	WHEEL GUARDS	SWING UP JOCKEY	SEALED BEARING UNITS	LED LIGHTS	WALKWAY	SPARE WHEEL & CARRIER
V LITE SERIES																
TQLITE	460 LITE WEIGHT 650KG 13" L/SKIDS	650	640	4660	160	2030	X	13"	STEEL	STD	✓	DOLLY	STD	N/A	N/A	NA
TQLITE10	370 LITE WEIGHT 600KG 10" S/SKIDS	600	640	3850	140	1890	X	10"	STEEL	STD	✓	DOLLY	STD	N/A	N/A	NA
TQLITE13	400 LITE WEIGHT 600KG 13" L/SKIDS	600	640	4400	160	2030	X	13"	STEEL	STD	✓	DOLLY	STD	N/A	N/A	NA
V LINE SERIES																
TQ37	310-370 V-LINE 700KG 10" S/SKIDS	700	640	4070	160	1890	X	10"	ALLOY	STD	✓	SMALL	STD	OPT	OPT	OPT
TQ42	380-420 V-LINE 700KG 13" L/SKIDS	700	1040	4420	160	2040	X	13"	ALLOY	STD	✓	SMALL	STD	OPT	OPT	OPT
TQ46	430-460 V-LINE 749KG 13" L/SKIDS	749	700	4800	210	2040	X	13"	ALLOY	STD	✓	SMALL	STD	OPT	STD	OPT
TQ46B	430-460 V-LINE 1000KG 13" L/SKIDS BRAKE	1000	700	4800	210	2040	✓	13"	ALLOY	STD	✓	SMALL	STD	OPT	STD	OPT
TQ46BW	430-460 V-LINE 1000KG 13" L/SKIDS WIDE BRAKE	1000	700	4800	210	2270	✓	13"	ALLOY	STD	✓	SMALL	STD	OPT	STD	OPT
TQ46W	430-460 V-LINE 749KG 13" L/SKIDS WIDE	749	700	4800	210	2270	X	13"	ALLOY	STD	✓	SMALL	STD	OPT	STD	OPT
TQ48	460-480 V-LINE 749KG 13" L/SKID	749	700	5450	260	2040	X	13"	ALLOY	STD	✓	SMALL	STD	OPT	STD	OPT
TQ48B	460-480 V-LINE 1000KG 13" L/SKID BRAKED	1000	1040	5450	260	1990	✓	13"	ALLOY	STD	✓	8"	STD	OPT	STD	OPT
V LOADER SERIES																
TQ48VB	460-480 VLOADER 1000KG 13" BRAKED	1100	700	5450	260	2040	✓	13"	ALLOY	STD	✓	8"	STD	STD	STD	OPT
TQ48VBH	460-480 VLOADER 1180KG 13" BRAKED	1180	700	5450	260	2040	✓	13"	ALLOY	STD	✓	8"	STD	STD	STD	OPT
TQ48VBHW	460-480 VLOADER 1180KG 13" BRAKED WIDE	1180	700	5450	260	2270	✓	13"	ALLOY	STD	✓	8"	STD	STD	STD	OPT
TQ51VB	480-510 VLOADER 1000KG 13" BRAKED	1000	700	5720	320	2040	✓	13"	ALLOY	STD	✓	8"	STD	STD	STD	OPT
TQ51VBH	480-510 VLOADER 1180KG 13" BRAKED	1180	700	5720	320	2040	✓	13"	ALLOY	STD	✓	8"	STD	STD	STD	OPT
TQ51VBH4	480-510 VLOADER 1450KG 14" BRAKED	1450	780	5720	320	2040	✓	14"	ALLOY	STD	✓	8"	STD	STD	STD	OPT
WIDE FRAME V LOADER SERIES																
TQ51VBH4W	480-510 VLOADER 1450KG 14" BRAKED WIDE	1450	780	5720	320	2270	✓	14"	ALLOY	STD	✓	8"	STD	STD	STD	OPT
TQ51VBHW	480-510 VLOADER 1180KG 13" BRAKED WIDE	1180	700	5720	320	2270	✓	13"	ALLOY	STD	✓	8"	STD	STD	STD	OPT
TQ58VBW	510-580 VLOADER 1450KG 14" BRAKED WIDE	1450	780	5800	320	2320	✓	14"	ALLOY	STD	✓	8"	STD	STD	STD	OPT
TQ61VBW	580-620 VLOADER 1450KG 14" BRAKED WIDE	1450	780	6400	380	2320	✓	14"	ALLOY	STD	✓	8"	STD	STD	STD	OPT
TQ61VBWT	580-620 VLOADER 2000KG 13" BRAKED WIDE TANDEM	2000	700	6400	420	2270	✓	13"	ALLOY	STD	✓	8"	STD	STD	STD	OPT
TQ66VBWT	620-660 VLOADER 2000KG 13" BRAKED WIDE TANDEM	2000	700	7120	420	2270	✓	13"	ALLOY	STD	✓	8"	STD	STD	STD	OPT
TQ70VBWT	660-700 VLOADER 2000KG 13" BRAKED WIDE TANDEM	2000	700	7120	420	2270	✓	13"	ALLOY	STD	✓	8"	STD	STD	STD	OPT
TQ70VBWT25	660-700 VLOADER 2500KG 14" BRAKED WIDE TANDEM	2500	780	7330	580	2270	✓	14"	ALLOY	STD	✓	8"	STD	STD	STD	OPT
ALUMINIUM SERIES																
TQAVL48B	460-480 ALLOY VL ATM 1100KG 13" BRAKE	1000	700	5680	280	2030	✓	13"	ALLOY	STD	✓	8"	STD	STD	TBA	OPT
TQAVL48BH	460-480 ALLOY VL ATM 1298KG 13" BRAKE	1298	700	5680	280	2030	✓	13"	ALLOY	STD	✓	8"	STD	STD	TBA	OPT
TQAVL51BH	480-510 ALLOY VL ATM 1298KG 13" BRAKE	1298	700	5680	280	2030	✓	13"	ALLOY	STD	✓	8"	STD	STD	TBA	OPT
TQAVL51BW	480-550 ALLOY VL ATM 1400KG 13" BRAKE WIDE	1400	700	5900	280	2300	✓	13"	ALLOY	STD	✓	8"	STD	STD	TBA	OPT
TQAVL58BW	510-580 ALLOY VL ATM 1595KG 14" BRAKE WIDE	1595	700	5900	300	2300	✓	14"	ALLOY	STD	✓	8"	STD	STD	TBA	OPT
TQAVL61BW	580-620 ALLOY VL ATM 1700KG 14" BRAKE WIDE	1700	700	6250	380	2300	✓	14"	ALLOY	STD	✓	8"	STD	STD	TBA	OPT
TQAVL61BWT	580-620 ALLOY VL ATM 2000KG 13" TANDEM BRAKE WIDE	2000	700	6250	380	2300	✓	13"	ALLOY	STD	✓	8"	STD	STD	TBA	OPT
TQAVL66BWT	620-660 ALLOY VL ATM 2000KG 13" TANDEM BRAKE WIDE	2000	700	6620	400	2300	✓	13"	ALLOY	STD	✓	8"	STD	STD	TBA	OPT
TQAVL70BWT	660-700 ALLOY VL ATM 2000KG 13" TANDEM BRAKE WIDE	2000	700	7100	420	2300	✓	13"	ALLOY	STD	✓	8"	STD	STD	TBA	OPT
TQAVL70BWT25	660-700 ALLOY VL ATM 2750KG 14" TANDEM BRAKE WIDE	2750	700	7100	500	2300	✓	14"	ALLOY	STD	✓	8"	STD	STD	TBA	OPT

Standard = ✓ Not Applicable = X

These trailers are designed for use on sealed roads only and are not recommended for consistent off-road use. Measurements and weights are subject to variation.

Recommended trailer ATM's are based on standard boat and trailer weights, max motor weight and full fuel. Ensure that your particular requirements and intended use do not exceed these provisions. Placing the boat on a non-specified trailer may void boats warranty.

GALVANISED WALKWAY



LED LIGHTS



SPARE WHEEL CARRIER

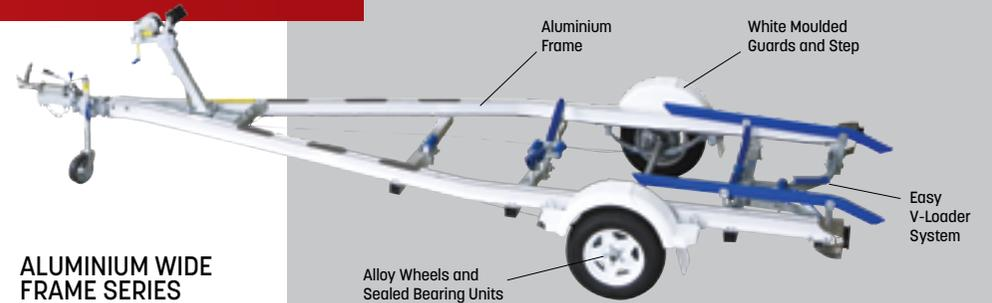

ALUMINIUM WIDE FRAME SERIES



For more information on the Stacer range, options available, recent news and events plus more visit stacer.com.au

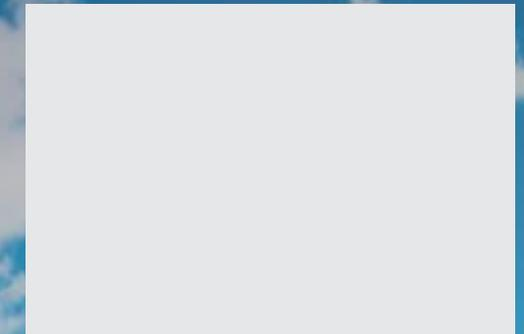

WARRANTY

The contents of this brochure will not form part of any contractual agreement. Stacer recommends that all persons comply with their local boating regulations and are familiar with safe boating practices. This brochure is designed to provide you with an introduction to the Stacer products. Stacer reserves the right at any time, at its discretion, and without notice, to discontinue or change the features, designs, materials, colours, specifications and the prices of its products, and to either permanently or temporarily withdraw any such products from the market without incurring any liability to any prospective purchaser. Details referred to in this brochure are based on pre-production specifications and could be altered or deleted prior to the boat's sale date. Because of variations which occur in manufactured products, all capacities, measurements, dimensions and weights quoted should be taken as approximates only and are subject to change. Every effort has been made to depict boat colours and trims as realistically as possible in this brochure, however some variation may occur due to printing limitations. Always consult with an authorised Stacer dealer for the latest information with respect to features, specifications, prices, optional equipment and availability before deciding to purchase. Stacer do not offer factory direct sales or prices. For updated specifications including warranty, please refer to the Stacer website: www.stacer.com.au

*Telwater Pty Ltd 15 010 795 507
53 Waterway Drive, Coomera, Queensland 4209 Australia.
Version 1 Printed July 2012